

Jürgen Appell; Marilda A. Simões; Petr P. Zabrejko
On the \mathcal{L} -characteristic of fractional powers of linear operators

Commentationes Mathematicae Universitatis Carolinae, Vol. 35 (1994), No. 1, 21--34

Persistent URL: <http://dml.cz/dmlcz/118637>

Terms of use:

© Charles University in Prague, Faculty of Mathematics and Physics, 1994

Institute of Mathematics of the Academy of Sciences of the Czech Republic provides access to digitized documents strictly for personal use. Each copy of any part of this document must contain these *Terms of use*.



This paper has been digitized, optimized for electronic delivery and stamped with digital signature within the project *DML-CZ: The Czech Digital Mathematics Library* <http://project.dml.cz>

On the \mathcal{L} -characteristic of fractional powers of linear operators

JÜRGEN APPELL, MARILDA A. SIMÕES, PETR P. ZABREJKO

Abstract. We describe the geometric structure of the \mathcal{L} -characteristic of fractional powers of bounded or compact linear operators over domains with arbitrary measure. The description builds essentially on the Riesz-Thorin and Marcinkiewicz-Stein-Weiss-Ovchinnikov interpolation theorems, as well as on the Krasnosel'skij-Krejn factorization theorem.

Keywords: fractional powers of operators, L -characteristic, Lebesgue spaces, interpolation theorems

Classification: 47A57, 47B37, 47B38, 46E30

The aim of this paper is to provide, by means of a simple geometric visualization, some results on fractional powers of self-adjoint operators in Banach spaces. The most advanced and complete theory refers to the scale of (real or complex) Lebesgue spaces $L_p = L_p(\Omega)$ ($1 \leq p \leq \infty$) over some compact domain Ω in Euclidean space; a full account may be found in the book [13], where results from [7]–[12] and [18] are reported in detail. In the present paper we consider the L_p -scale over arbitrary sets Ω equipped with a σ -finite measure; this covers, for example, the scale of sequence spaces l_p ($1 \leq p \leq \infty$). Moreover, we give a more precise description of some aspects of fractional powers; this gives more information even in the very classical case $\Omega = [0, 1]$. Finally, we discuss essentially new results on fractional powers which may be obtained by replacing the classical Riesz-Thorin theorem [22], [25] by sharper interpolation theorems; these theorems have been initiated by Marcinkiewicz [15], essentially enlarged by Stein and Weiss [24], and recently completed by Ovchinnikov [17].

In this connection, we would like to point the reader's attention to a problem which was raised in the paper [26] and is still unsolved. Apart from the independent interest in interpolation theory, its solution would have far-reaching consequences in many fields of both linear and nonlinear analysis, where fractional powers of operators occur. We shall come back to this problem in the last section.

1. Fractional powers in Hilbert space

Let Ω be an arbitrary nonempty set, \mathcal{M} a σ -algebra of subsets of Ω , and μ a countably additive and σ -finite measure on \mathcal{M} . By $L_p = L_p(\Omega)$ ($1 \leq p \leq \infty$) we denote the space of all (classes of) μ -measurable functions which are p -integrable ($p < \infty$) resp. essentially bounded ($p = \infty$) on Ω , equipped with the

usual algebraic operations and norm. We have to distinguish the case of real and complex functions; from time to time it will be stated explicitly which case we refer to.

Let $A : L_2 \rightarrow L_2$ be a positive definite self-adjoint linear operator which is not necessarily bounded, but densely defined ($\overline{D(A)} = L_2$). As is well known, such an operator admits a representation

$$Ax = \int_0^\infty \lambda dP_\lambda x \quad (x \in D(A)),$$

where $\{P_\lambda\}_\lambda$ denotes the corresponding spectral family. For $-\infty < \tau < \infty$, the fractional powers A^τ may be defined by

$$(1) \quad A^\tau x = \int_0^\infty \lambda^\tau dP_\lambda x.$$

The fractional powers A^τ with $0 \leq \tau \leq 1$ are of particular importance in interpolation theory.

In what follows, we shall be interested in fractional powers of linear operators A between L_p and L_q . Denote by $\mathcal{L}(A, \text{cont.})$ [resp. $\mathcal{L}(A, \text{comp.})$] the set of all pairs $(\frac{1}{p}, \frac{1}{q}) \in [0, 1] \times [0, 1]$ such that $\overline{D(A)} \cap L_p = L_p$ and $A : L_p \rightarrow L_q$ is continuous [resp. compact]. Following [13], we call $\mathcal{L}(A, \dots)$ the \mathcal{L} -characteristic of A . Since A is self-adjoint, the set $\mathcal{L}(A, \dots)$ is always symmetric with respect to the line $\frac{1}{p} + \frac{1}{q} = 1$.

Let us recall two important special cases. First, if μ is finite on Ω we have $L_{p_1} \supseteq L_{p_2}$ for $p_1 \leq p_2$, and thus $\mathcal{L}(A, \dots)$ contains, together with any point $(\frac{1}{p}, \frac{1}{q})$, also the rectangle $R^c = \text{co}\{(\frac{1}{p}, \frac{1}{q}), (\frac{1}{p}, 1), (0, 1), (0, \frac{1}{q})\}$. Second, if μ is purely atomic on Ω and $\mu(s)$ is bounded away from zero for any $s \in \Omega$, we have $L_{p_1} \subseteq L_{p_2}$ for $p_1 \leq p_2$, and thus $\mathcal{L}(A, \dots)$ contains, together with any point $(\frac{1}{p}, \frac{1}{q})$, also the rectangle $R^d = \text{co}\{(\frac{1}{p}, \frac{1}{q}), (\frac{1}{p}, 0), (1, 0), (1, \frac{1}{q})\}$ (see Fig. 1).

One basic problem we shall be concerned with is the following. Once you know the \mathcal{L} -characteristic $\mathcal{L}(A, \text{cont.})$, describe the \mathcal{L} -characteristic $\mathcal{L}(A^\tau, \text{cont.})$ for $0 \leq \tau \leq 1$, and make this description as explicit as possible.

2. Some auxiliary results

In what follows, the basic tools will be the theorems of Riesz-Thorin [13], [22], [25] and Marcinkiewicz-Stein-Weiss [13], [15], [24], [27] on the interpolation of continuous operators, the Krasnosel'skij-Krejn theorem [10], [13] on the decomposition of operators over L_2 , and the Krasnosel'skij theorem [9], [13] on the interpolation of compact operators.

The *Riesz-Thorin theorem* ([22], [25] or [13, Theorem 2.4]) states that the \mathcal{L} -characteristic $\mathcal{L}(A, \text{cont.})$ is always a convex set, and the norm of A from $L_{p(\lambda)}$ into $L_{q(\lambda)}$ satisfies the estimate

$$(2) \quad \|A\|_{p(\lambda) \rightarrow q(\lambda)} \leq C \|A\|_{p(0) \rightarrow q(0)}^{1-\lambda} \|A\|_{p(1) \rightarrow q(1)}^\lambda$$

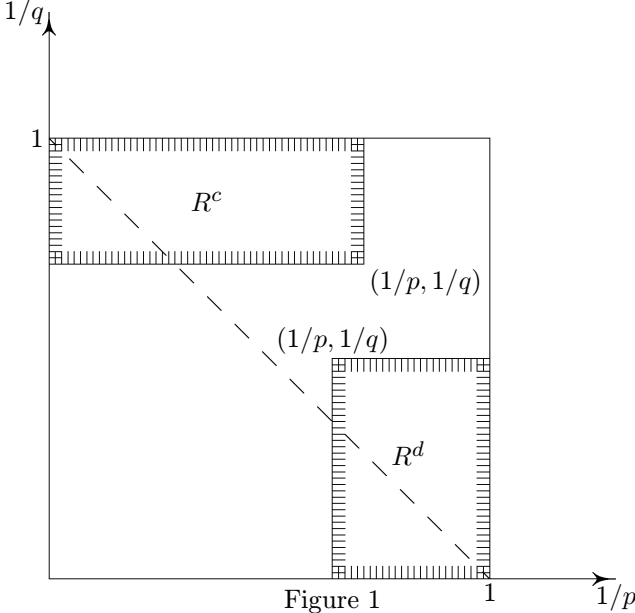

Figure 1

for

$$(3) \quad \frac{1}{p(\lambda)} = \frac{1-\lambda}{p(0)} + \frac{\lambda}{p(1)}, \quad \frac{1}{q(\lambda)} = \frac{1-\lambda}{q(0)} + \frac{\lambda}{q(1)}.$$

In the complex case one may take $C = 1$ in (2) (i.e. the left-hand norm is a logarithmically convex function of $\lambda \in [0, 1]$), while in the real case one has to take $C = 2$ in (2). However, if $p(0) \leq q(0)$ and $p(1) \leq q(1)$, (2) holds also in the real case with $C = 1$.

The *Krasnosel'skij theorem* ([9] or [13, Theorem 5.4]) states that the \mathcal{L} -characteristic $\mathcal{L}(A, \text{comp.})$ is convex as well. It should be emphasized, however, that the boundary of $\mathcal{L}(A, \text{cont.})$ in many cases does not belong to $\mathcal{L}(A, \text{comp.})$ [26].

Following [13], we say that an operator A satisfies *Condition* $\Lambda M(\alpha, \beta)$ ($0 \leq \alpha, \beta \leq 1$) if the measure μ is atomic-free and

$$(4) \quad \int_E (A\chi_D)(s) ds = O((\mu D)^\alpha (\mu E)^{1-\beta})$$

for any $D, E \in \mathcal{M}$. This condition means, in the language of interpolation theory, that A acts from the Lorentz space Λ_α into the Marcinkiewicz space M_β , see e.g. [1], [2], [14]. In particular, if one of the three acting conditions

$$A(\Lambda_\alpha) \subseteq L_{1/\beta}, \quad A(L_{1/\alpha}) \subseteq L_{1/\beta}, \quad A(L_{1/\alpha}) \subseteq M_\beta$$

is satisfied, the operator A satisfies Condition $\Lambda M(\alpha, \beta)$; moreover, all three conditions are stronger than Condition $\Lambda M(\alpha, \beta)$. This fact will be used several times in Section 4 below.

The *Marcinkiewicz-Stein-Weiss theorem* ([15], [24], [27] or [13, Theorem 2.9 and Theorem 8.2]) states that, whenever A satisfies Condition $\Lambda M\left(\frac{1}{p(0)}, \frac{1}{q(0)}\right)$ and Condition $\Lambda M\left(\frac{1}{p(1)}, \frac{1}{q(1)}\right)$, where $p(0) \leq q(0)$, $p(1) \leq q(1)$, and $q(0) \neq q(1)$, one has $\left(\frac{1}{p(\lambda)}, \frac{1}{q(\lambda)}\right) \in \mathcal{L}(A, \text{cont.})$ for $0 < \lambda < 1$ and $p(\lambda)$, $q(\lambda)$ as in (3).

Throughout, for a given $p \in [1, \infty]$ we denote the conjugate index of p by p' , i.e. $p' = \frac{p}{p-1}$ for $1 < p < \infty$, $1' = \infty$, and $\infty' = 1$.

The *Krasnosel'skij-Krejn theorem* ([10] or [13, Theorem 9.1 and Theorem 9.2]) states that $\left(\frac{1}{p}, \frac{1}{p'}\right) \in \mathcal{L}(A, \dots)$ implies $\left(\frac{1}{p}, \frac{1}{2}\right) \in \mathcal{L}(A^{1/2}, \dots)$, $\left(\frac{1}{2}, \frac{1}{p'}\right) \in \mathcal{L}(A^{1/2}, \dots)$, and

$$(5) \quad \max\{\|A^{1/2}\|_{p \rightarrow 2}, \|A^{1/2}\|_{2 \rightarrow p'}\} \leq \|A\|_{p \rightarrow p'}^{1/2}.$$

Here the points in the \mathcal{L} -characteristic denote either continuity or compactness. In an abstract form, this theorem may be formulated as follows. Let H be a Hilbert space, X and Y two Banach spaces such that $Y \subseteq X^*$ and $X \subseteq Y^*$ (continuous imbeddings), and $A : H \rightarrow H$ a densely defined self-adjoint operator such that $\overline{D(A)} \cap X = X$, and A is continuous [resp. compact] from X into Y . Then the square root $A^{1/2}$ of A is continuous [resp. compact] both from X into H and from H into Y (see again [13]).

3. Application of the Riesz-Thorin theorem

In this section we prove two theorems on the \mathcal{L} -characteristic of fractional powers of a self-adjoint operator A . We begin with the following

Lemma 1. *Let $0 \leq \tau(0), \tau(1) \leq 1$, and suppose that $A^{\tau(0)}$ maps L_2 into $L_{q(0)}$, and $A^{\tau(1)}$ maps L_2 into $L_{q(1)}$. Then A^τ maps L_2 into L_q , where*

$$(6) \quad \tau = \frac{1}{2}(\tau(0) + \tau(1)), \quad \frac{1}{q} = \frac{1}{2} \left(\frac{1}{q(0)} + \frac{1}{q(1)} \right).$$

Moreover,

$$(7) \quad \|A^\tau\|_{2 \rightarrow q}^2 \leq C \|A^{\tau(0)}\|_{2 \rightarrow q(0)} \|A^{\tau(1)}\|_{2 \rightarrow q(1)},$$

where $C = 1$ in the complex case, and $C = 2$ in the real case.

PROOF: Since A is self-adjoint, $A^{\tau(0)}$ acts also from $L_{q'(0)}$ into L_2 , and $A^{\tau(1)}$ from $L_{q'(1)}$ into L_2 . Thus, $A^{\tau(0)+\tau(1)}$ acts both from $L_{q'(0)}$ into $L_{q(1)}$ and from $L_{q'(1)}$

into $L_{q(0)}$. By the Riesz-Thorin interpolation theorem, $A^{\tau(0)+\tau(1)}$ acts then from $L_{q'}$ into L_q , and

$$\|A^{\tau(0)+\tau(1)}\|_{q' \rightarrow q} \leq C \|A^{\tau(0)}\|_{2 \rightarrow q(0)} \|A^{\tau(1)}\|_{2 \rightarrow q(1)}.$$

The assertion follows now from the Krasnosel'skij-Krejn theorem, by the choice (6) of τ and q . \square

Of course, if $A^{\tau(0)}$ and $A^{\tau(1)}$ are compact between the spaces given in Lemma 1, then A^τ is also compact between L_2 and L_q ; this is an immediate consequence of the Krasnosel'skij interpolation theorem for compact operators.

Theorem 1. *Let $0 \leq \tau(0), \tau(1) \leq 1$, and suppose that $(\frac{1}{2}, \frac{1}{q(0)}) \in \mathcal{L}(A^{\tau(0)}, \text{cont.})$ and $(\frac{1}{2}, \frac{1}{q(1)}) \in \mathcal{L}(A^{\tau(1)}, \text{cont.})$. Then $(\frac{1}{2}, \frac{1}{q(\lambda)}) \in \mathcal{L}(A^{\tau(\lambda)}, \text{cont.})$ for any $\lambda \in [0, 1]$, where*

$$(8) \quad \tau(\lambda) = (1 - \lambda)\tau(0) + \lambda\tau(1), \quad \frac{1}{q(\lambda)} = \frac{1 - \lambda}{q(0)} + \frac{\lambda}{q(1)}.$$

Moreover,

$$(9) \quad \|A^{\tau(\lambda)}\|_{2 \rightarrow q(\lambda)} \leq C \|A^{\tau(0)}\|_{2 \rightarrow q(0)}^{1-\lambda} \|A^{\tau(1)}\|_{2 \rightarrow q(1)}^\lambda,$$

where $C = 1$ in the complex case, and $C = 2$ in the real case.

PROOF: Observe that Theorem 1 gives Lemma 1 for $\lambda = \frac{1}{2}$. Conversely, it is not hard to see that Lemma 1 implies Theorem 1. In fact, for $\lambda = j2^{-k}$ ($j = 1, 2, \dots, 2^k - 1; k = 1, 2, \dots$) we get by induction that

$$\|A^{\tau(\lambda)}\|_{2 \rightarrow q(\lambda)} \leq C^{1-2^{-k}} \|A^{\tau(0)}\|_{2 \rightarrow q(0)}^{1-\lambda} \|A^{\tau(1)}\|_{2 \rightarrow q(1)}^\lambda$$

which for $k = 1$ (hence $j = 1$ and $\lambda = \frac{1}{2}$) is the assertion of Lemma 1. Approximating now an arbitrary $\lambda \in [0, 1]$ by a sequence of such numbers and using the continuity of (9) with respect to λ and the moment inequality for fractional powers [13, Theorem 12.1] proves Theorem 1. \square

We remark that Theorem 1 was proved in the case of a bounded domain $\Omega \subset \mathbb{R}^N$ with the Lebesgue measure μ in [13, Theorem 10.3 and Theorem 12.13].

Let us illustrate the assertion of Theorem 1 by Fig. 2 for the special choice $\tau(0) = 0$ and $\tau(1) = 1$, i.e. $A^{\tau(0)} = I$ and $A^{\tau(1)} = A$, where we have sketched only the lower right square $[\frac{1}{2}, 1] \times [0, \frac{1}{2}]$.

Of course, $\mathcal{L}(I, \text{cont.})$ consists in the "generic case" just of the one point $\{(\frac{1}{2}, \frac{1}{2})\}$. Let $B = (\frac{1}{2}, \frac{1}{q}) \in \mathcal{L}(A, \text{cont.})$ for some $q > 2$. We have then $B' =$

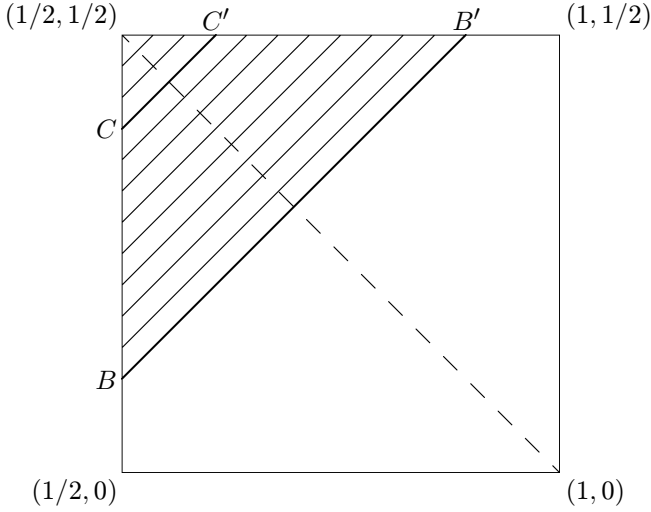

Figure 2

$\left(\frac{1}{q}, \frac{1}{2}\right) \in \mathcal{L}(A, \text{cont.})$, by symmetry, and $\text{co}\{B, B'\} \subseteq \mathcal{L}(A, \text{cont.})$, by the Riesz-Thorin theorem. Theorem 1 implies that the segment $\text{co}\{C, C'\}$ belongs then to $\mathcal{L}(A^\lambda, \text{cont.})$, where $C = \left(\frac{1}{2}, \frac{(1-\lambda)q+2\lambda}{2q}\right)$ and $C' = \left(\frac{(1+\lambda)q-2\lambda}{2q}, \frac{1}{2}\right)$. Thus, the union of the \mathcal{L} -characteristics of $A^{\tau(\lambda)}$ covers the whole triangle $\text{co}\left\{\left(\frac{1}{2}, \frac{1}{2}\right), B, B'\right\}$ as λ (and hence $\tau(\lambda)$) runs over the interval $[0, 1]$.

We point out that Fig. 2 often reflects only a small part of the \mathcal{L} -characteristic $\mathcal{L}(A^{\tau(\lambda)}, \text{cont.})$. For example, if the measure μ is continuous and bounded, or purely atomic and bounded away from zero, one can stick the rectangle R^c or R^d , resp., of Fig. 1 at each point of $\mathcal{L}(A^{\tau(\lambda)}, \text{cont.})$.

We now give an important generalization of Theorem 1 which we state as

Theorem 2. *Let $0 \leq \tau(0), \tau(1) \leq 1$, and suppose that $\left(\frac{1}{q'(0)}, \frac{1}{q(0)}\right) \in \mathcal{L}(A^{\tau(0)}, \text{cont.})$ and $\left(\frac{1}{q'(1)}, \frac{1}{q(1)}\right) \in \mathcal{L}(A^{\tau(1)}, \text{cont.})$. Then*

$$(10) \quad \text{co} \left\{ \left(\frac{1}{p'(\lambda)}, \frac{1}{q(1)} \right), \left(\frac{1}{q'(1)}, \frac{1}{p(\lambda)} \right) \right\} \subseteq \mathcal{L}(A^{\tau(\lambda)}, \text{cont.})$$

for any $\lambda \in [0, 1]$, where $\tau(\lambda)$ and $q(\lambda)$ are given by (8), and

$$(11) \quad \frac{1}{p(\lambda)} = \frac{1}{q'(\lambda)} + \frac{1}{q(\lambda)} - \frac{1}{q'(\lambda)}, \frac{1}{p'(\lambda)} = 1 - \frac{1}{p(\lambda)}.$$

PROOF: We illustrate the proof of Theorem 2 by a geometrical reasoning on the \mathcal{L} -characteristic of $A^{\tau(\lambda)}$ (see Fig. 3), where we assume again that $\tau(0) = 0$ and $\tau(1) = 1$.

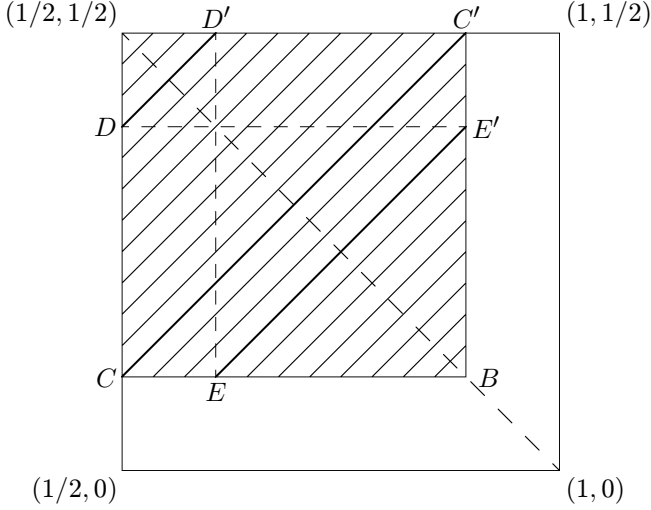

Figure 3

By hypothesis, we are now given a point $B = \left(\frac{1}{q'}, \frac{1}{q}\right) \in \mathcal{L}(A, \text{cont.})$ on the diagonal, where $q = q(1)$. Let $C = \left(\frac{1}{2}, \frac{1}{q}\right)$ and $C' = \left(\frac{1}{q'}, \frac{1}{2}\right)$. We get $C, C' \in \mathcal{L}(A^{1/2}, \text{cont.})$, by Krasnosel'skij's theorem, and $\text{co}\{C, C'\} \subseteq \mathcal{L}(A^{1/2}, \text{cont.})$ by the Riesz-Thorin theorem. Moreover, from Theorem 1 we conclude that $\text{co}\{D, D'\} \subseteq \mathcal{L}(A^{\lambda/2}, \text{cont.})$, where $D = \left(\frac{1}{2}, \frac{(1-\lambda)q+2\lambda}{2q}\right)$ and $D' = \left(\frac{(1+\lambda)q-2\lambda}{2q}, \frac{1}{2}\right)$.

Consider now the point $E = \left(\frac{(1+\lambda)q-2\lambda}{2q}, \frac{1}{q}\right)$.

From $D' = \left(\frac{(1+\lambda)q-2\lambda}{2q}, \frac{1}{2}\right) \in \mathcal{L}(A^{\lambda/2}, \text{cont.})$ and $C = \left(\frac{1}{2}, \frac{1}{q}\right) \in \mathcal{L}(A^{1/2}, \text{cont.})$ it follows that $E \in \mathcal{L}(A^{(1+\lambda)/2}, \text{cont.})$, and thus also $\text{co}\{E, E'\} \subseteq \mathcal{L}(A^{(1+\lambda)/2}, \text{cont.})$, where $E' = \left(\frac{1}{q'}, \frac{(1-\lambda)q+2\lambda}{2q}\right)$. Since $\frac{\lambda}{2}$ runs over the interval $[0, \frac{1}{2}]$ and $\frac{1+\lambda}{2}$ runs over the interval $[\frac{1}{2}, 1]$ as $0 \leq \lambda \leq 1$, we conclude that the union of the \mathcal{L} -characteristics of $A^{\tau(\lambda)}$ covers the whole square $\text{co}\left\{\left(\frac{1}{2}, \frac{1}{2}\right), B, C, C'\right\}$. □

Observe that for $q'(0) = q'(1) = 2$ we get $q'(\lambda) = 2$ and $p(\lambda) = q(\lambda)$ in (11). This shows that Theorem 1 is a special case of Theorem 2. Moreover, applying Theorem 2 to the midpoint of the interpolation scale (10) we conclude that $\left(\frac{1}{q'(\lambda)}, \frac{1}{q(\lambda)}\right) \in \mathcal{L}(A^{\tau(\lambda)}, \text{cont.})$ and

$$(12) \quad \|A^{\tau(\lambda)}\|_{q'(\lambda) \rightarrow q(\lambda)} \leq C \|A^{\tau(0)}\|_{q'(0) \rightarrow q(0)}^{1-\lambda} \|A^{\tau(1)}\|_{q'(1) \rightarrow q(1)}^{\lambda}$$

which in turn generalizes (9).

4. Application of the Stein-Weiss theorem

The two theorems of the preceding section build, apart from the Krasnosel'skij-Krejn decomposition, on the classical Riesz-Thorin interpolation theorem. One should expect that these theorems admit a refinement if one replaces the Riesz-Thorin theorem by the more sophisticated Stein-Weiss theorem. This is in fact true; we briefly describe the necessary modifications. A crucial point in the proof of Lemma 1 was the fact that, if the operator $A^{\tau(0)+\tau(1)}$ acts both from $L_{q'(0)}$ into $L_{q(1)}$ and from $L_{q'(1)}$ into $L_{q(0)}$, then it also acts from $L_{q'}$ to L_q with $\frac{1}{q} = \frac{1}{2}(\frac{1}{q(0)} + \frac{1}{q(1)})$ and $\frac{1}{q'} = \frac{1}{2}(\frac{1}{q'(0)} + \frac{1}{q'(1)})$. Now, the Stein-Weiss interpolation theorem tells us that this holds true if $A^{\tau(0)+\tau(1)}$ acts merely from $\Lambda_{1/q'(0)}$ into $M_{1/q(1)}$, and from $\Lambda_{1/q'(1)}$ into $M_{1/q(0)}$ i.e. satisfies both Condition $\Lambda M\left(1 - \frac{1}{q(0)}, \frac{1}{q(1)}\right)$ and Condition $\Lambda M\left(1 - \frac{1}{q(1)}, \frac{1}{q(0)}\right)$ ($q(0), q(1) \geq 2$). For this in turn it suffices to require in the hypotheses of Lemma 1 that $A^{\tau(j)}$ maps L_2 into the Marcinkiewicz space $M_{1/q(j)}$ ($j = 0, 1$). We thus arrive at the following refinement of Theorem 1.

Theorem 3. *Let $0 \leq \tau(0), \tau(1) \leq 1$ and $q(0), q(1) \geq 2$, and suppose that $A^{\tau(0)}(L_2) \subseteq M_{1/q(0)}$ and $A^{\tau(1)}(L_2) \subseteq M_{1/q(1)}$. Then the assertion of Theorem 1 holds for $0 < \lambda < 1$.*

We shall not prove Theorem 3, since it is a special case of the following Theorem 4. In fact, applying the Stein-Weiss theorem, rather than the Riesz-Thorin theorem, in the proof of Theorem 2, we arrive at the following

Theorem 4. *Let $0 \leq \tau(0), \tau(1) \leq 1$ and $q(0), q(1) \geq 2$, and suppose that $A^{\tau(0)}(\Lambda_{1/q'(0)}) \subseteq M_{1/q(0)}$ and $A^{\tau(1)}(\Lambda_{1/q'(1)}) \subseteq M_{1/q(1)}$. Then the assertion of Theorem 2 holds for $0 < \lambda < 1$.*

PROOF: First assume that $\lambda = 1/2$. By the generalized Krasnosel'skij-Krejn factorization theorem, $A^{\tau(j)/2}$ maps $\Lambda_{1/q'(j)}$ into L_2 and consequently maps L_2 into $M_{1/q(j)}$. By composition, the operator $A^{(\tau(0)+\tau(1))/2}$ satisfies Conditions $\Lambda M(1 - \frac{1}{q(0)}, \frac{1}{q(1)})$ and $\Lambda M(1 - \frac{1}{q(1)}, \frac{1}{q(0)})$. The Stein-Weiss interpolation theorem implies that this operator maps $L_{1/q'(\lambda)}$ into $L_{1/q(\lambda)}$, the midpoint of the interpolation scale. The proof is completed for general λ by iterating this midpoint argument as was done in the proof of Theorem 1. □

Let us visualize the statement of Theorem 3 again in the case $\tau(0) = 0$ and $\tau(1) = 1$. The \mathcal{L} -characteristic of $A^0 = I$ is again $\mathcal{L}(I; \text{cont.}) = \{(\frac{1}{2}, \frac{1}{2})\}$. If we suppose that A maps L_2 into some Marcinkiewicz space M_β ($0 < \beta < \frac{1}{2}$), then A maps, by symmetry, the Lorentz space $\Lambda_{1-\beta}$ into L_2 . This does not imply, of course, that $B = (\frac{1}{2}, \beta) \in \mathcal{L}(A, \text{cont.})$ or $B' = (1 - \beta, \frac{1}{2}) \in \mathcal{L}(A, \text{cont.})$. However, the Marcinkiewicz-Stein-Weiss theorem tells us that the open segment $(\text{co}\{B, B'\}) \setminus \{B, B'\}$ belongs to the \mathcal{L} -characteristic $\mathcal{L}(A, \text{cont.})$ (see Fig. 4). By

Theorem 1, the whole interior of the triangle $co\{(\frac{1}{2}, \frac{1}{2}), B, B'\}$ is covered by the union of the \mathcal{L} -characteristics $\mathcal{L}(A^{\tau(\lambda)}, \text{cont.})$ as λ runs over the interval $[0, 1]$.

Thus, the only question arises whether or not the points on the boundary $co\{(\frac{1}{2}, \frac{1}{2}), B\}$ (and, by symmetry, on the boundary $co\{(\frac{1}{2}, \frac{1}{2}), B'\}$) belong to $\mathcal{L}(A^{\tau(\lambda)}, \text{cont.})$. Now, if $C = (\frac{1}{2}, \frac{1}{q})$ is any point strictly above B (i.e. $\beta q < 1$), the acting condition $A^{\tau(\lambda)}(L_2) \subseteq M_\beta$ implies that $C \in \mathcal{L}(A^{\tau(\lambda)}, \text{cont.})$. Thus, all points of the semi-open segment $(co\{(\frac{1}{2}, \frac{1}{2}), B\}) \setminus \{B\}$ belong to the union of the \mathcal{L} -characteristics of $A^{\tau(\lambda)}$ (see again Fig. 4).

If we illustrate Theorem 4 on the \mathcal{L} -characteristics $\mathcal{L}(A^{\tau(\lambda)}, \text{cont.})$ we get Fig. 5 below. The point $B = (\frac{1}{q'}, \frac{1}{q})$ corresponds to the acting condition $A(\Lambda_{1/q'}) \subseteq M_{1/q}$ (and thus does not necessarily belong to $\mathcal{L}(A, \text{cont.})$). Similarly, the points $C = (\frac{1}{2}, \frac{1}{q})$ and $C' = (\frac{1}{q'}, \frac{1}{2})$ correspond to the acting conditions $A^{1/2}(L_2) \subseteq M_{1/q}$ and $A^{1/2}(\Lambda_{1/q'}) \subseteq L_2$ (and thus do not necessarily belong to $\mathcal{L}(A^{1/2}, \text{cont.})$ either). But already the open segment $(co\{C, C'\}) \setminus \{C, C'\}$ belongs to $\mathcal{L}(A^{1/2}, \text{cont.})$, by the Marcinkiewicz-Stein-Weiss theorem. Repeating the above reasoning, one sees that the whole square $co\{(\frac{1}{2}, \frac{1}{2}), B, C, C'\}$, except for the lower boundary $co\{B, C\}$ and the right boundary $co\{B, C'\}$, is covered by the union of the \mathcal{L} -characteristics $\mathcal{L}(A^{\tau(\lambda)}, \text{cont.})$.

5. Ménagement à trois

Theorem 1 refers to the case when we are given, except for the point $(\frac{1}{2}, \frac{1}{2})$, some point on the vertical line $\frac{1}{p} = \frac{1}{2}$ which belongs to the \mathcal{L} -characteristic of A . On the other hand, Theorem 2 refers to the case when we are given, except for the point $(\frac{1}{2}, \frac{1}{2})$, some point on the diagonal line $\frac{1}{p} + \frac{1}{q} = 1$ which belongs to the \mathcal{L} -characteristic of A . Combining these hypotheses, i.e. assuming that $B = (\frac{1}{2}, \frac{1}{q}) \in \mathcal{L}(A, \text{cont.})$ and $C = (\frac{1}{p'}, \frac{1}{p}) \in \mathcal{L}(A, \text{cont.})$, where $2 < p < q < \infty$, and letting the three points $(\frac{1}{2}, \frac{1}{2}), B$, and C play simultaneously (“ménage à trois”) gives a much more interesting picture.

First of all, by the Riesz-Thorin theorem we have then

$$co\{B, B', C\} \subseteq \mathcal{L}(A, \text{cont.})$$

(see Fig. 6).

The construction of $\mathcal{L}(A^{1/2}, \text{cont.})$, say, goes then as follows. By Theorem 1, we know that the segment $co\{D, D'\}$ belongs to $\mathcal{L}(A^{1/2}, \text{cont.})$, where $D = (\frac{1}{2}, \frac{1}{4} + \frac{1}{2q})$ is the midpoint between $(\frac{1}{2}, \frac{1}{2})$ and B , and $D' = (\frac{1}{4} + \frac{1}{2q}, \frac{1}{2})$ is its counterpart. On the other hand, by Theorem 2 we know that both points $F = (\frac{1}{2}, \frac{1}{p})$ and $F' = (\frac{1}{p}, \frac{1}{2})$ belong to $\mathcal{L}(A^{1/2}, \text{cont.})$ as well, and hence

$$(14) \quad co\{D, D', F, F'\} \subseteq \mathcal{L}(A^{1/2}, \text{cont.})$$

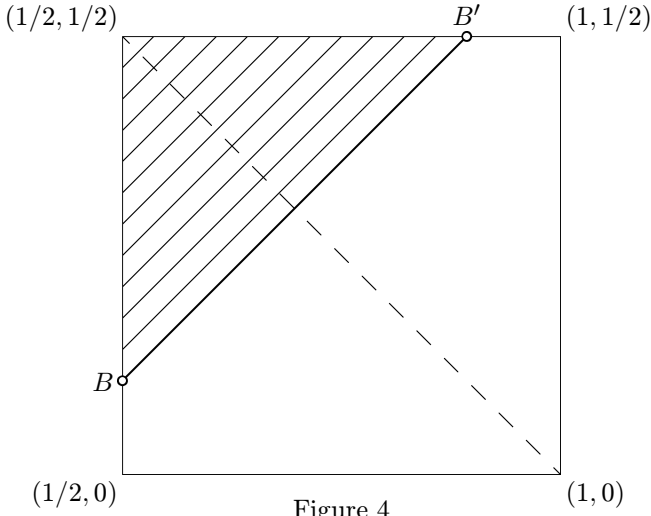

Figure 4

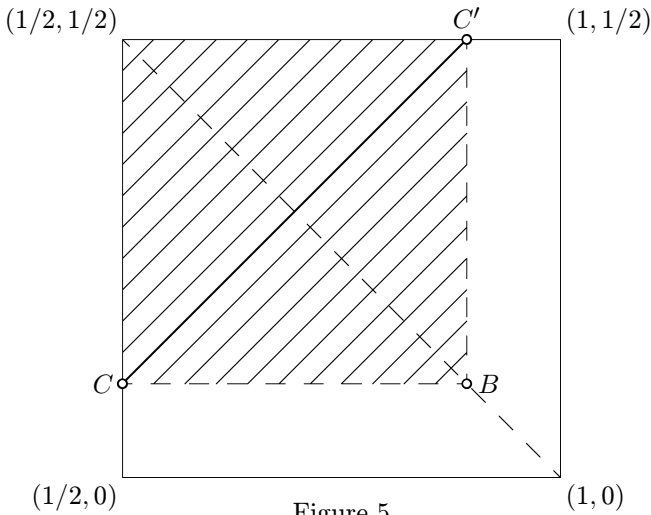

Figure 5

(see again Fig. 6).

Let us now construct $\mathcal{L}(A^{1/4}, \text{cont.})$ and $\mathcal{L}(A^{3/4}, \text{cont.})$, say. From $D, D' \in \mathcal{L}(A^{1/2}, \text{cont.})$ and Theorem 1 it follows that $G, G' \in \mathcal{L}(A^{1/4}, \text{cont.})$, where $G = \left(\frac{1}{2}, \frac{3}{4} + \frac{1}{2q}\right)$ is the midpoint between $(\frac{1}{2}, \frac{1}{2})$ and D , and $G' = \left(\frac{3}{4} + \frac{1}{2q'}, \frac{1}{2}\right)$ is its counterpart. Furthermore, since the midpoint $H = \left(\frac{1}{4} + \frac{1}{2p'}, \frac{1}{4} + \frac{1}{2p}\right)$ between F and F' belongs to $\mathcal{L}(A^{1/2}, \text{cont.})$, we conclude from Theorem 2 that $J, J' \in$

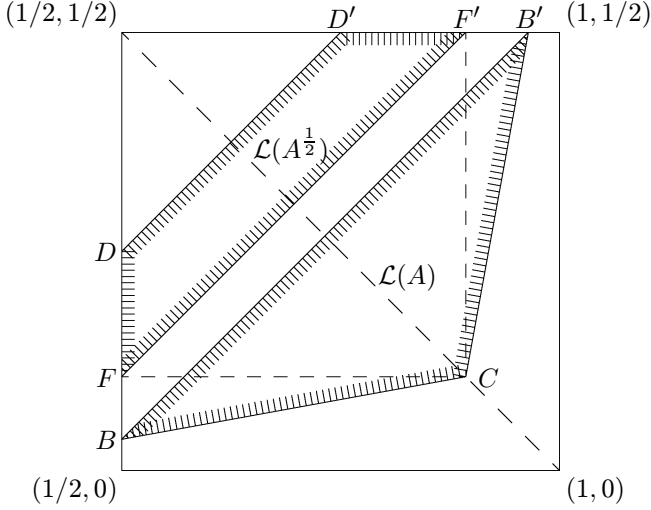

Figure 6

$\mathcal{L}(A^{1/4}, \text{cont.})$, where $J = \left(\frac{1}{2}, \frac{1}{4} + \frac{1}{2p}\right)$ and $J' = \left(\frac{1}{4} + \frac{1}{2p'}, \frac{1}{2}\right)$. Consequently (see Fig. 7),

$$(15) \quad \text{co}\{G, G', J, J'\} \subseteq \mathcal{L}(A^{1/4}, \text{cont.}).$$

From $B, B' \in \mathcal{L}(A, \text{cont.})$ and $D, D' \in \mathcal{L}(A^{1/2}, \text{cont.})$ we conclude that $K, K' \in \mathcal{L}(A^{3/4}, \text{cont.})$, where $K = \left(\frac{1}{2}, \frac{1}{8} + \frac{3}{4q}\right)$ is the midpoint between B and D , and $K' = \left(\frac{1}{8} + \frac{3}{4q'}, \frac{1}{2}\right)$. Similarly, from $B, B' \in \mathcal{L}(A, \text{cont.})$ and $F, F' \in \mathcal{L}(A^{1/2}, \text{cont.})$ it follows that $L, L' \in \mathcal{L}(A^{3/4}, \text{cont.})$, where $L = \left(\frac{1}{2}, \frac{1}{2p} + \frac{1}{2q}\right)$ is the midpoint between B and F , and $L' = \left(\frac{1}{2p'} + \frac{1}{2q'}, \frac{1}{2}\right)$. Moreover, if $M = \left(\frac{1}{4} + \frac{1}{2p'}, \frac{1}{4} + \frac{1}{2p}\right)$ denotes the midpoint between F and F' , then the midpoint $N = \left(\frac{1}{8} + \frac{3}{4p'}, \frac{1}{8} + \frac{3}{4p}\right)$ between C and M lies on the boundary of $\mathcal{L}(A^{3/4}, \text{cont.})$. Finally, denoting $P = \left(\frac{1}{4} + \frac{1}{2p'}, \frac{1}{p}\right)$ and $P' = \left(\frac{1}{p'}, \frac{1}{4} + \frac{1}{2p}\right)$, we have (see again Fig. 7)

$$(16) \quad \text{co}\{K, K', L, L', P, P'\} \subseteq \mathcal{L}(A^{3/4}, \text{cont.}).$$

In this way, one may visualize the \mathcal{L} -characteristic of $A^{\tau(\lambda)}$ for any $\lambda \in [0, 1]$ and, in particular, see how $\mathcal{L}(A^{\tau(\lambda)}, \text{cont.})$ shrinks continuously, as λ decreases from 1 to 0, to the point $\left(\frac{1}{2}, \frac{1}{2}\right)$. By our choice of p and q , the whole “ménage” takes place in the lower right quadrant. If one chooses points B and C in different quadrants of the square $[0, 1] \times [0, 1]$, the picture may become more sophisticated. We do not know, however, whether to every such picture there corresponds an operator A with such an \mathcal{L} -characteristic.

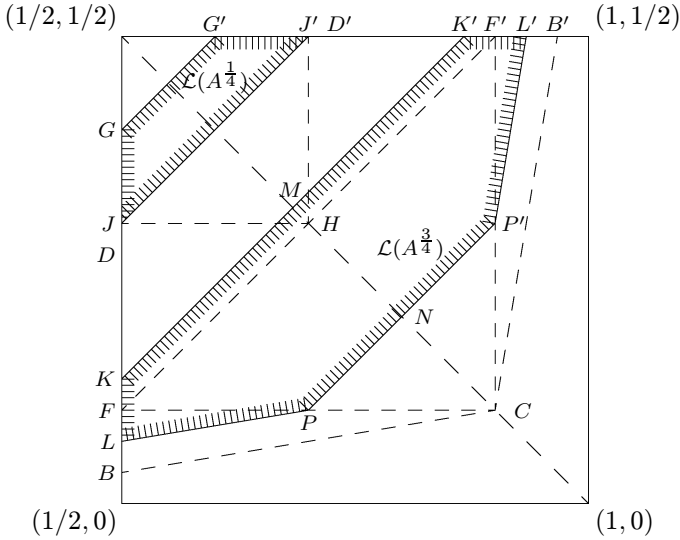

Figure 7

It is clear that, building on Theorem 3 and Theorem 4, one may repeat the constructions of this section, just starting from the weaker Condition $\Lambda M(\alpha, \beta)$. Since this is parallel to Section 4, we shall not go into the details.

6. Concluding remarks

One of our main tasks in the preceding sections consisted in constructing a possibly large portion of some \mathcal{L} -characteristic, starting from just two or three points in the square $[0, 1] \times [0, 1]$. Since all operators were supposed to be self-adjoint, we always obtained portions which are symmetric with respect to the diagonal $\frac{1}{p} + \frac{1}{q} = 1$. Conversely, it was observed by B.S. Mitjagin (see [10]) that any convex subset Σ of the square $[0, 1] \times [0, 1]$ which is symmetric with respect to the diagonal $\frac{1}{p} + \frac{1}{q} = 1$, is the \mathcal{L} -characteristic (possibly, up to boundary points), of some continuous selfadjoint operator A . A complete characterization of all possible \mathcal{L} -characteristics was obtained by S.D. Riemenschneider in [20], [21]: In case $\Omega = [0, 1]$ equipped with the Lebesgue measure μ , a set $\Sigma \subseteq [0, 1] \times [0, 1]$ is precisely the \mathcal{L} -characteristic of a continuous operator if and only if Σ is convex, F_σ , and monotone (i.e. contains together with any point $(\frac{1}{p}, \frac{1}{q})$ the rectangle R^c given in Fig. 1) [20]. Similarly, in case $\Omega = [0, \infty)$ an analogous statement holds without the monotonicity requirement on Σ .

It is clear that, given an arbitrary convex F_σ set $\Sigma \subseteq [0, 1] \times [0, 1]$, we can recover in general only a small portion of Σ by applying the above interpolation theorems (namely any subset Π which is bounded by some polygon, see Fig. 8). The problem how to find all the other points of $\mathcal{L}(A^\tau, \text{cont.})$ from $\mathcal{L}(A, \text{cont.})$, except those already recovered by means of interpolation theorems, was raised

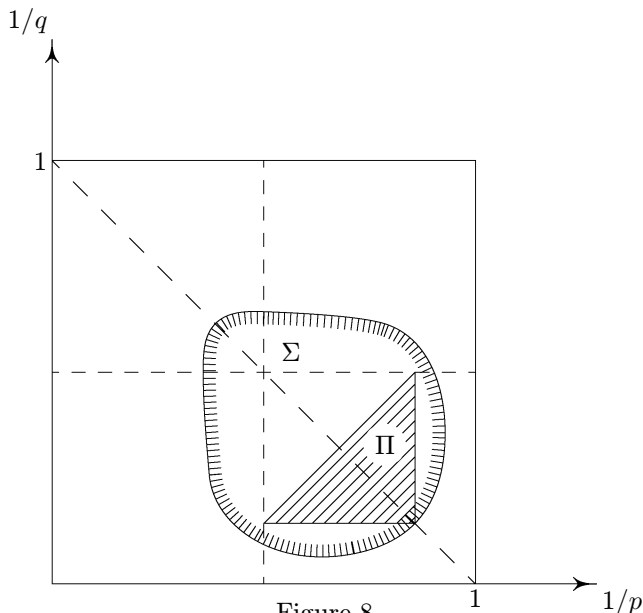

Figure 8

in [26] and is, to our knowledge, still unsolved.

The methods and results discussed in the present paper may be extended in different directions. For example, one could combine the assumptions on the Lebesgue spaces L_p , on the one hand, and the Lorentz spaces Λ_α and Marcinkiewicz spaces M_β , on the other, by considering the general interpolation spaces $L(p, q)$ (see e.g. [3], [6], [16]). Further, one could consider fractional powers of operators in Orlicz spaces (see e.g. [19], [23]), or even in general Calderón scales [4], [5] of spaces of measurable functions, and try to apply abstract interpolation theorems [2], [3], [14].

REFERENCES

- [1] Bergh J., Löfström J., *Interpolation spaces – an introduction*, Springer, Berlin, 1976.
- [2] Brudnyj Ju.A., Krejn S.G., Semenov E. M., *Interpolation of linear operators* (in Russian), *Itogi Nauki Tekhniki* **24** (1986), 3–163 [Engl. transl.: *J. Soviet Math.* **42** (1988), 2009–2113].
- [3] Butzer P.L., Berens H., *Semigroups of operators and approximation*, Springer, Berlin, 1967.
- [4] Calderón A.P., *Intermediate spaces and interpolation: the complex method*, *Studia Math.* **24** (1964), 113–190.
- [5] Calderón A.P., Zygmund A., *A note on the interpolation of linear operators*, *Studia Math.* **12** (1951), 194–204.
- [6] Hunt R.A., *On $L(p, q)$ spaces*, *Enseignement Math.* **12** (1966), 249–276.
- [7] Krasnosel'skij M.A., *Decomposition of operators from L_q into L_p* (in Russian), *Dokl. Akad. Nauk SSSR* **82**, **3** (1952), 333–336.
- [8] ———, *Properties of the root of a linear integral operator* (in Russian), *Dokl. Akad. Nauk SSSR* **88**, **5** (1953), 749–751.
- [9] ———, *On a theorem of M. Riesz* (in Russian), *Dokl. Akad. Nauk SSSR* **131**, **2** (1960), 246–248.

- [10] Krasnosel'skij M.A., Krejn S.G., *Criteria for the continuity and complete continuity of a linear operator in terms of properties of its square* (in Russian), Trudy Sem. Funk. Anal. Voronezh. **5** (1957), 98–101.
- [11] Krasnosel'skij M.A., Pustyl'nik E.I., *Using fractional powers of operators in the investigation of Fourier series expansion with respect to eigenfunctions of differential operators* (in Russian), Dokl. Akad. Nauk SSSR **122, 6** (1958), 978–981.
- [12] Krasnosel'skij M.A., Zabrejko P.P., *On the L -characteristic of operators* (in Russian), Uspekhi Mat. Nauk **19** (1964), 187–189.
- [13] Krasnosel'skij M.A., Zabrejko P.P., Pustyl'nik E.I., Sobolevskij P.E., *Integral operators in spaces of summable functions* (in Russian), Nauka, Moscow 1966 [Engl. transl.: Noordhoff, Leyden, 1976].
- [14] Krejn S.G., Petunin Ju.I., Semenov E.M., *Interpolation of linear operators* (in Russian), Nauka, Moscow 1978 [Engl. transl.: Math. Monogr. Amer. Math. Soc., Providence, 1982].
- [15] Marcinkiewicz J., *Sur l'interpolation d'opérateurs*, C.R. Acad. Sci. Paris **208** (1939), 1272–1273.
- [16] O'Neil R., *Convolution operators and $L(p, q)$ spaces*, Duke Math. J. **30, 1** (1963), 129–142.
- [17] Ovchinnikov V.I., *An exact interpolation theorem in L_p spaces* (in Russian), Dokl. Akad. Nauk SSSR **272, 2** (1983), 300–303.
- [18] Pustyl'nik E.I., *On fractional powers of unbounded positive operators* (in Ukrainian), Dokl. Akad. Nauk UkrSSR **10** (1961), 1266–1270.
- [19] Rao M.M., Ren Z.D., *Theory of Orlicz spaces*, Dekker Inc., New York, 1991.
- [20] Riemenschneider S.D., *The L -characteristics of linear operators on $L^{1/\alpha}([0, 1])$* , J. Funct. Anal. **8** (1971), 405–421.
- [21] ———, *Linear operators on $L^{1/\alpha}(0, \infty)$ and Lorentz spaces: the Krasnosel'skii-Zabrejko characteristic sets*, Studia Math. **49** (1974), 225–233.
- [22] Riesz M., *Sur les maxima des formes bilinéaires et sur les fonctionnelles linéaires*, Acta Math. **49** (1926), 465–497.
- [23] Rutitskij Ja.B., *Scales of Orlicz spaces and interpolation theorems* (in Russian), Dokl. Akad. Nauk SSSR **149, 1** (1963), 32–35.
- [24] Stein E.M., Weiss G., *An extension of a theorem of Marcinkiewicz and some of its applications*, J. Math. Mech. **8, 2** (1959), 263–284.
- [25] Thorin G.O., *An extension of a convexity theorem due to M. Riesz*, Comm. Sem. Math. Lund **4** (1939), 1–5.
- [26] Zabrejko P.P., Krasnosel'skij M.A., Pustyl'nik E.I., *A problem for fractional powers of operators* (in Russian), Uspekhi Mat. Nauk **20, 6** (1965), 87–89.
- [27] Zygmund A., *On a theorem of Marcinkiewicz concerning interpolation*, J. Pure Appl. Math. **9** (1956), 223–248.

UNIVERSITÄT WÜRZBURG, MATHEMATISCHE FAKULTÄT, AM HUBLAND, D-97074 WÜRZBURG, GERMANY

UNIVERSITÀ DI NAPOLI, ISTITUTO DI MATEMATICA, VIA MONTEOLIVETO 3, I-80134 NAPOLI, ITALY

BELGOSUNIVERSITET, MATEMATICHESKIJ FAKUL'TET, PL. NEZAVISIMOSTI, 220080 MINSK, BELORUSSIA

(Received November 9, 1992)