

I. Pelant

Condensation of excitons in highly excited semiconductors

Acta Universitatis Carolinae. Mathematica et Physica, Vol. 14 (1973), No. 1, 143--154

Persistent URL: <http://dml.cz/dmlcz/142302>

Terms of use:

© Univerzita Karlova v Praze, 1973

Institute of Mathematics of the Academy of Sciences of the Czech Republic provides access to digitized documents strictly for personal use. Each copy of any part of this document must contain these *Terms of use*.



This paper has been digitized, optimized for electronic delivery and stamped with digital signature within the project *DML-CZ: The Czech Digital Mathematics Library* <http://project.dml.cz>

Condensation of Excitons in Highly Excited Semiconductors*

I. PELANT

Department of Chemical Physics, Faculty of Mathematics and Physics,
Charles University, Prague

The paper deals with the problem of a collective behaviour of excitons in semiconductors at low temperatures. Some recent theoretical papers concerning the calculation of the ground-state energy of so-called electron-hole drops are reviewed. Typical experimental results are presented, which show, that sufficient high concentration of excitons in Ge and Si leads to their condensation into "liquid" with metallic character of conductivity. This model of condensed phase, that is assumed to be constituted of spherical drops (electron-hole drops), is compared with another foregoing model of excitonic complex, i.e. the excitonic molecule.

1. Introduction

It is well known that non-equilibrium electrons and holes in semiconductors and ionic crystals may be bound by Coulomb forces and form excitons, that may be understood as a specific atomic boson gas. In connection with now easily available high optical excitation intensities (the laser), a problem of certain interactions have been widely studied in recent years, e.g. the exciton-lattice defect, exciton—photon, exciton—phonon, exciton—electron and exciton—exciton interactions. In this paper, we wish to discuss in some details the lastly mentioned type of interaction. It has been intensively studied in the following three groups of solids:

- typical semiconductors of the type of Ge, Si
- intermetallic compounds of the type $A^{II} B^{VI}$ (CdS, CdSe)
- ionic crystals (CuCl).

Let us start with a question: What happens, if we produce sufficiently high exciton concentration in the semiconductor such that the mean distance between excitons will be equal to their radius? Apparently, one may expect a formation of certain excitonic complexes. One of them is an excitonic molecule — biexciton, theoretically predicted by Lampert [1]. In analogy with the hydrogenic molecule one can imagine the biexciton as a quasiparticle consisted of two electrons and two holes. A tendency of the biexciton formation should rise with $\sigma = m_h/m_e$, σ being the ratio of the effective hole mass m_h to the effective electron mass m_e . On the other hand,

*) This paper had not been presented at the seminar and it has been added into the volume as a complementary paper to the review article of R. Levy and J. B. Grun.

Keldyš in 1968 had proposed another possibility of exciton collectivization: after him, excitons at high concentrations will behave as another gas under high pressure i.e. at definite critical concentration (being dependent on temperature) will condense into a “liquid” phase and will form a liquid of the metallic type. In such a liquid the electrons will be not further bound with their holes and both types of carriers will move more or less independently. For this case of the semiconductor-metal phase transition a term “condensation of exciton into electron-hole drops” has been accepted. It is clear the occurrence of a region with metallic conductivity inside the semiconductor must be followed by substantial changes of many of its physical properties.

Let us mention in advance, that on the basis of contemporary theoretical works and experimental results we are not able to say quite *unambiguously* what type of introduced excitonic complexes will come into existence in real semiconductor. It is possible the excitonic molecules are formed at relatively low concentrations of excitons, while the condensed phase appears at higher concentrations only [3]–[5]. Another possibility seems to be more probable, namely that in dependence on the specific band structure of concrete semiconductor, or biexcitons, or electron-hole drops will exist (we will mention it later). However, in typical semiconductors Ge and Si the great majority of experimental results is in good agreement with the model of condensed phase. For that reason, this paper summarizes those theoretical and experimental works, dealing with the problem of collective behaviour of excitons from the electron-hole drops formation point of view.

2. Theory

2.1. Ground-state energy of electron-hole drops

Ground-state energy level of the exciton lies in energy gap. Its distance from a bottom of the conduction band is equal to E_b^{ex} , the binding energy of the exciton. The condensation will take place only if the corresponding ground-state energy level per electron-hole pair in the drops lies below E_b^{ex} . First, let us therefore mention the question of a calculation of the mean ground-state energy E_0 per electron-hole pair. It is the matter of many-electron problem, where, in the Hartree – Fock approximation together with introduction of a correlation energy, E_0 can be written

$$E_0 = E_g + E_{kin}^e + E_{kin}^h - E_{ex}^e - E_{ex}^h + E_{cor} = E_{HF} + E_{cor}, \quad (1)$$

where E_g is the band gap, E_{kin}^e and E_{kin}^h the mean kinetic energies of electrons and holes, E_{ex}^e and E_{ex}^h the mean exchange energies of electrons and holes, and E_{cor} the mean correlation energy that includes contributions of second and higher orders in the Coulomb interaction. From expression (1), E_0 can be calculated as a function of the carrier density n in the drop or, if you like, the mean interparticle separation r_g . All terms in (1) can be calculated exactly for any band structure. For an ideal case of simple bands with spherical masses m_e , m_h at $T = 0^\circ\text{K}$ the calculation has

been made by Benoît à La Guillaume et al. [6]. They found the function (1) has a minimum $E_{om} \approx E_g - (2/3) R_o + E_{cor}$, where $R_o = \mu e^4 / 2 \hbar^2 \epsilon^2$ is the free exciton Rydberg (μ — reduced mass, ϵ — static dielectric constant). However, to obtain the condensed phase stable, the condition $E_{om} < E_g - R_o$ must be fulfilled. So the final result depends on the contribution coming from E_{cor} . The correlation energy has been calculated by Brinkman et al. [7]. To calculate E_{cor} , they used

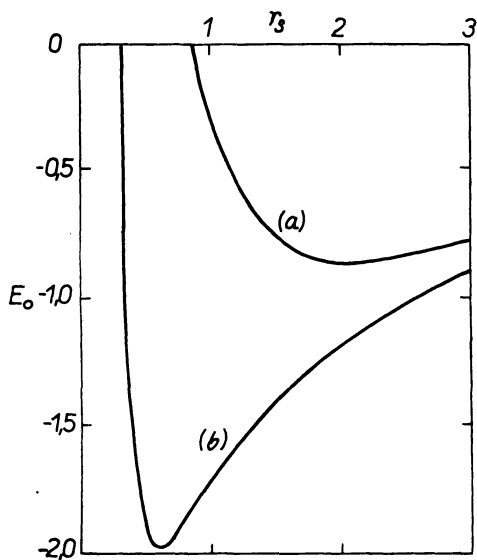

Fig. 1. The ground state energy E_o versus the interparticle spacing r_s . The units are R_o and a_o . Curve (a), an ideal isotropic band structure with $m_e = m_h$; curve (b), the real band structure of Ge [7]

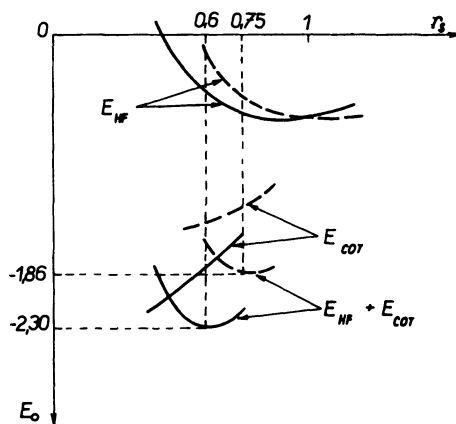

Fig. 2. The ground state energy E_o for Ge (after [9]). The dotted lines, Ge under the $\langle 111 \rangle$ stress $P = 3 \text{ kg mm}^{-2}$. Corresponding band structure for such a stress is shown by insert (b) in Fig. 7

a generalized approximation introduced originally by Hubbard for the isotropic electron gas [8]. Their result for the above-mentioned simple case is represented by the curve *a* in Fig. 1. The energy (with origin at the bottom of the conduction band) is measured in units R_o and the unit of r_s is the Bohr radius of exciton $a_o = \epsilon \hbar^2 / \mu e^2$ (for the free exciton $E_o = -1$ and $r_s = 1$). The curve has a minimum $E_{om} = -0.86$ at $r_s = 2.0$. One can see that even including E_{cor} the condensed phase is not bound here with respect to the free exciton ($E_{om} > -1$). It is therefore important to take into account a real band structure. The authors [7] have done it for Ge and, using the same method for the calculation E_{cor} as in the preceding case, have obtained the curve *b* in Fig. 1. The curve has a minimum $E_{om} \approx -2$ at $r_s = 0.63$. In contrast to the foregoing simple case the condensed phase in Ge is strongly bound. The equilibrium value of r_s corresponds to the electron concentration $n_e = 1.8 \cdot 10^{17} \text{ cm}^{-3}$.

The Hubbard's approximation cannot be exactly extended to complicated band structure of Ge (the electron masses at four conduction band minima have been assumed to be spherical and the existence of different light and heavy holes has been ignored). Combescot and Nozières [9] have obtained E_{cor} by the interpolation method [10] that makes possible to take into account the anisotropy of the conduction band so as the interaction between light and heavy holes. They found $E_{om} = -2.3$ at $r_s = 0.6$ ($n_c = 2 \cdot 10^{17} \text{ cm}^{-3}$) (Fig. 2). The more exact calculation has consequently provided further binding of electron-hole drops, by about 15%.

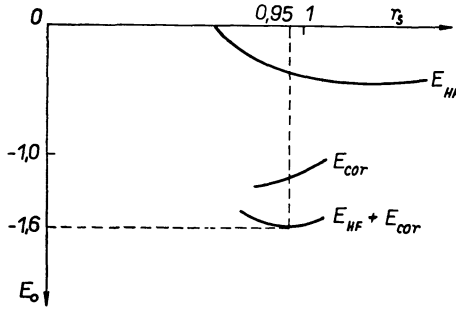

Fig. 3. The ground state energy for Si [9]

physical units, in Ge $R_0 = 2.64 \text{ meV}$ [9] and $E_{om} = -6.1 \text{ meV}$. Seeing that the experimental value $E_b^{ex} = -3.6 \text{ meV}$, we get the binding energy of electron-hole drops with respect to the free exciton (or a "work function" from the condensed phase) $\varphi = 2.5 \text{ meV}$. The authors have also done the same calculation for Si (Fig. 3) and they obtained $E_{om} = -21 \text{ meV}$, $n_c = 3.1 \cdot 10^{18} \text{ cm}^{-3}$ and $\varphi = 7 \text{ meV}$. Evidently, the complicated multivalley band structures of Ge and Si are favourable for the stability of electron-hole drops (see the note in introduction). To confirm this statement, dotted lines in Fig. 2 have been calculated for Ge when a uniaxial pressure P is applied in the $\langle 111 \rangle$ crystallographic direction. It is known that under such a pressure the band structure of Ge simplifies (the electrons occupy just one from the four conduction band valleys — Fig. 7b). One can see from Fig. 2 that in this case the binding energy of condensed phase decreases: $E_{om} = -1.86$ at $r_s = 0.75$.

2.2. Recombination radiation of the condensed phase

As the condensat consists of the non-equilibrium electrons and holes, a specific radiation due to the electron-hole recombination is expected. The spectral distribution of the recombination radiation for phonon-assisted indirect transitions at $T = 0^\circ\text{K}$ is given by [6]

$$\mathcal{J}(h\nu) = \left(\frac{|D|^2}{|\Delta E|^2} \right) \int_{V_h} \int_{V_e} |H(\vec{k}_e, \vec{k}_h)|^2 \times \\ \times \delta(h\nu - E_g - E_{kin}^e - E_{kin}^h + \hbar\omega) d\vec{k}_e d\vec{k}_h,$$

where D is the optical matrix element, ΔE the usual energy denominator, $H(\vec{k}_e, \vec{k}_h)$ the electron-phonon matrix element, $\hbar\omega$ the energy of the emitted phonon, V_h and V_e the volumes inside the hole and electron Fermi surfaces. From this equation one can derive a useful expression for the ratio of the free exciton and electron-hole drops radiative lifetimes denoted τ_R^{FE} and τ_R^{EHD} , respectively:

$$\frac{\tau_R^{\text{FE}}}{\tau_R^{\text{EHD}}} = \frac{n_c}{|\Phi_{\text{FE}}(0)|^2}. \quad (2)$$

This relation is valid for the case of allowed phonon involved in the recombination process and provides a method for experimental determination of n_c ($|\Phi_{\text{FE}}(0)|^2 = 1/64 \pi a_0^3$, where $\Phi_{\text{FE}}(\vec{r})$ is the wave function of the relative electron-hole motion of the free exciton).

A pictorial model of exciton condensation that predicts the dependence of the emission intensity on the excitation level and temperature, has been proposed by Pokrovskij and Svistunova [11]. For the case of steady-state excitation with the excitation level $g(\text{cm}^{-3} \text{s}^{-1})$ the following kinetic equation can be written

$$g = \frac{n^*}{\tau} + \mathcal{J}, \quad (3)$$

where n^* and τ are the concentration and non-radiative lifetime of free excitons in the gas phase, $\mathcal{J} = (n_c/\tau_R^{\text{EHD}}) NV$ is the radiative recombination rate in the condensed phase, N the concentration of electron-hole drops and $V = (4/3) \pi r^3$ the volume of a drop. The condensed phase is assumed to be constituted of spherical drops of radius r surrounded by free exciton gas. Under steady-state condition the current of particles from gas phase into drops, $n^* v N \pi r^2$, must be equal to the sum of the recombination rate \mathcal{J} inside drops and of the current of carries from drops due to thermal emission, $4\pi r^2 NAT^2 \exp(-\varphi/kT)$:

$$n^* v N \pi r^2 = \frac{n_c}{\tau_R^{\text{EHD}}} N \frac{4}{3} \pi r^3 + 4\pi r^2 NAT^2 e^{-\varphi/kT}. \quad (3)$$

Here v means the mean thermal velocity and A is Richardson constant. It follows from (2) and (3)

$$g - \frac{4AT^2 e^{-\varphi/kT}}{v\tau} = \frac{4}{3} \frac{n_c}{v\tau_R^{\text{EHD}}} \left(\frac{1}{\tau} + Nv\pi r^2 \right) r. \quad (4)$$

Thus $r \geq 0$ if $g - (4AT^2/v\tau) \exp(-\varphi/kT) \geq 0$. So the condensed phase can appear only if the threshold values of excitation level, g^{th} , and temperature, T^{th} , are reached:

$$g^{\text{th}} = \frac{4A (T^{\text{th}})^2 e^{-\varphi/kT^{\text{th}}}}{v\tau}$$

If g is small enough, we can assume $Nv\pi r^2 \ll 1/\tau$ and in this approximation the solution of (4) is $r \sim (g - g^{\text{th}})$. As the radiation intensity of the condensed phase $\mathcal{J} \sim r^3 N$, we have

$$\mathcal{J} \sim (g - g^{\text{th}})^3. \quad (5)$$

Therefore immediately after reaching threshold conditions, the radiation intensity \mathcal{J} should be proportional to the cube of the excitation level. However, at sufficiently low temperature and high excitation level, $g \gg g^{\text{th}}$, the majority of the nonequili-

brium carriers is concentrated in the condensed phase, so that $Nv\pi r^2 \gg 1/\tau$. Equation (4) then yields

$$\mathcal{J} \sim g, \quad (6)$$

or in this case \mathcal{J} depends linearly on the excitation level.

From (3), the temperature dependence of the radiation intensity \mathcal{J} can be also obtained [12]:

$$\mathcal{J} \sim \left\{ 1 - \exp \left[-\frac{\varphi}{k} \left(\frac{1}{T} - \frac{1}{T^{\text{th}}} \right) \right] \right\}^3. \quad (7)$$

3. Experimental results

To obtain sufficiently high concentrations of excitons in experiment, an optical excitation is most frequently used. The suitable excitation source for Ge and Si is a c.w. He-Ne laser generating output power of the order of ten mW at $\lambda = 0.632 \mu$ or 1.15μ , or a pulsed GaAs laser. However, high-pressure mercury or xenon lamps are used too. It is necessary to work near liquid helium temperature, because the critical temperature of the condensed phase is a few °K.

3.1. Observation of low-temperature luminescence of Ge and Si

The first experimental observation of electron-hole drops was through the low-temperature recombination radiation of Ge [13], [14], [11] and Si [15], [12]. In Fig. 4 is drawn the luminescence spectrum of pure Ge at different temperatures. At temperatures below T^{th} , besides emission bands at 714 meV and 706 meV originating from the recombination of free exciton with simultaneous emission of LA and TO

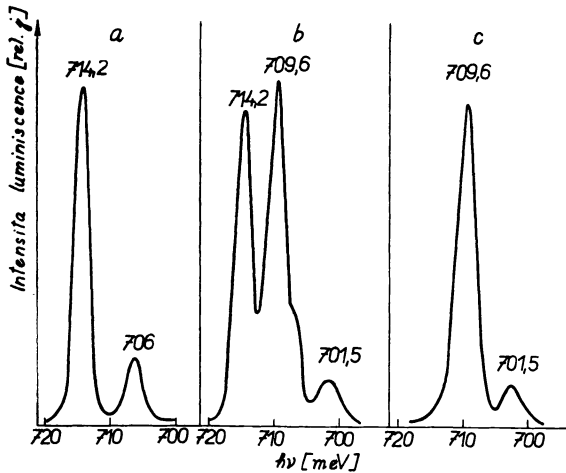

Fig. 4. Spectral distribution of the recombination radiation of pure Ge at different temperatures. a — 2,78°K, b — 2,52°K, c — 2,32°K [11]

phonons, a new intense radiation shifted to lower energies appears. These new emission bands with maxima at 709 meV and 701,5 meV have been attributed to the radiative annihilation of electron-hole drops. The mean binding energy $|E_{\text{om}}| \approx \approx 7.2$ meV, as obtained from Fig. 4, is in reasonable agreement with the theoretical value 6.1 meV [9]. Fig. 5 demonstrate the measured dependence of the long-wavelength luminescence intensity on the excitation level. The result can be characterized by the relations (5) and (6) very well. Fig. 6 shows the tempera-

ture dependence of \bar{J} for Ge at different excitation levels g . The solid curves correspond to the equation (7) with $\varphi = 1.5$ meV. In this case, there is also plausible agreement between theory and experiment. Benoît à La Guillaume et al. [16], [6] have measured the ratio of the free exciton and electron-hole drops radiative lifetimes in Ge. They found $\tau_R^{FE}/\tau_R^{EHD} \approx 16$ and from (2) the critical density of carriers in the condensed phase $n_c \approx 1.6 \cdot 10^{17} \text{ cm}^{-3}$ has been obtained. After all, also other measurement methods of the critical density determination, reviewed e.g. in [6], lead to good agreement with the theoretical value $n_c = 2 \cdot 10^{17} \text{ cm}^{-3}$ [9].

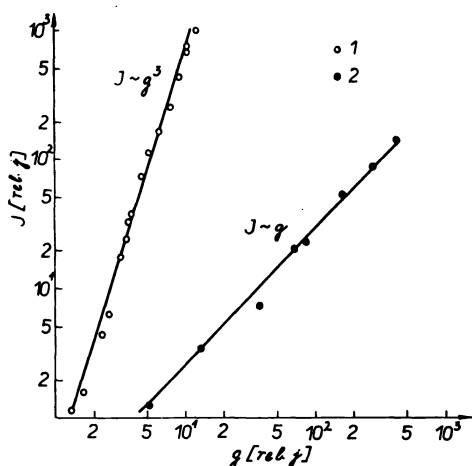

Fig. 5. Dependence of the long-wavelength luminescence of Ge on the excitation level g . $T = 2,1^\circ\text{K}$. 1 — under steady-state low excitation intensity, 2 — powerful lamp pulsed excitation [11]

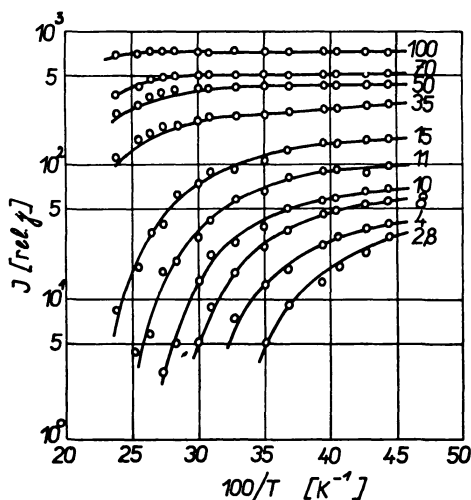

Fig. 6. Temperature dependence of the condensed phase radiation intensity of Ge under various steady-state photoexcitation levels. Relative values of g are shown on the side of each curve [19]

A similar state of affairs, when most of the experimental results are more or less in good agreement with the theory is in the case of silicon too*). A considerable difference between Ge and Si, however, is as for their quantum efficiency of the recombination radiation. The quantum yield of the condensed phase radiation in Ge is $\eta \approx 0.8$ [11], while this one in Si is about $5 \cdot 10^{-4}$ [18]. There is an assumption, that this difference is caused by an effective Auger recombination of electrons in the minima of the Si conduction band in the $\langle 100 \rangle$ direction. This hypothesis seems to be confirmed by the recent studies of the recombination radiation in Ge-Si alloys [19], [20].

An influence of a uniaxial mechanical stress on the luminescence spectra of Ge and Si has been studied in [6], [21] and [22]. Some results may be qualitatively com-

*) A new long-wavelength emission band attributed to the electron-hole drops recombination has been recently observed even in CdSe [17].

pared with the results of the ground-state energy calculation (sec. 2.1). Fig. 7 gives the shift of the maximum of the electron-hole drops main emission line in Ge versus the applied homogeneous pressure P . Although the band gap decreases with the applied pressure in Ge, a weak shift towards higher energies has been observed for

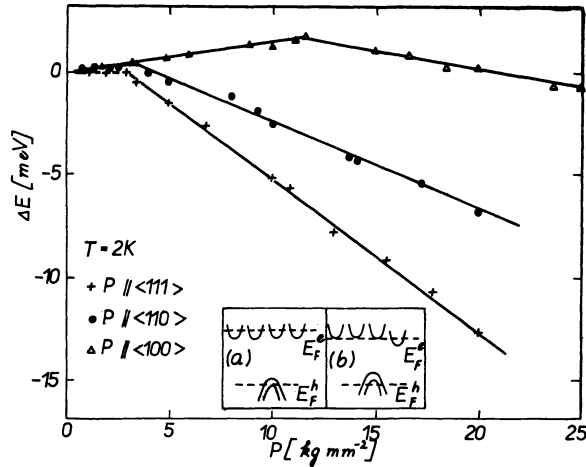

Fig. 7. Energy shift ΔE of the electron-hole drops main emission peak as a function of the applied uniaxial stress P . Schemes (a) and (b) correspond, respectively, to the situations occurring for $P = 11,5 \text{ kg mm}^{-2}$ in the $\langle 100 \rangle$ direction and for $P = 3 \text{ kg mm}^{-2}$ in the $\langle 111 \rangle$ direction [6]

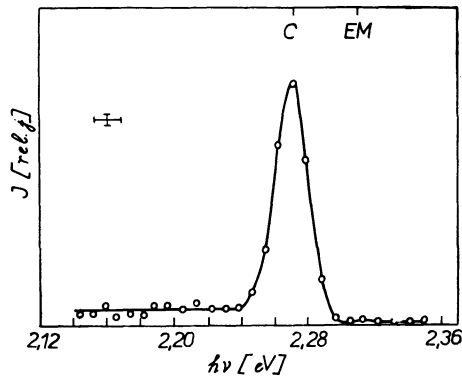

Fig. 8. High-energy two-electron luminescence from Si. The energetic position of the emission band maxima to be expected from the condensate model and the excitonic molecule model are indicated by C and EM respectively. The each experimental point measurement took 24 hours [23]

low stresses. It is because the decrease of E_g competes with the reduction of the mean binding energy of electron-hole pairs in the drop (Fig. 2). The change occurring for $P = 3 \text{ kg mm}^{-2}$ in the slope of the curve corresponding to P in the $\langle 111 \rangle$ direction

corresponds to the coincidence of the electron Fermi level in the lowest-energy conduction band with the bottom of the three others equivalent valleys. Then, as a matter of fact, all electrons ($T \rightarrow 0^\circ\text{K}$) occupy those lowest conduction band, that, with further increase of P , follows the corresponding decrease of E_g and the emission maximum shifts towards lower energies. Aleksejev et al. [22] have studied the low-temperature luminescence of the condensed phase in Ge under *nonuniform* uniaxial stress. To this purpose, they used samples of special shape. In these ones a force due to the stress gradient acted on the carriers. The drops were observed really to move above 4 mm from the surface to the middle of the sample. From this observation the value of effective mobility $6 \cdot 10^{18}$ sec/g has been established. After Aleksejev et al., this result cannot be explained by the excitonic molecule model and it serves as a further confirmation of the existence of electron-hole drops in semiconductors.

Let us mention one of luminescence experiments yet, namely the observation of the high energy luminescence near $2E_g$ due to radiative two-electron transitions in Si (Fig. 8 [23]). The energetic position and the linewidth agree very well with condensate model, too.

3.2. A Proof of electron-hole drops macroscopic character

Although most experiments deals with the recombination radiation of the condensed phase, the proof of *macroscopic character* of electron-hole drops has been done by another ways [24] — [26]. Benoît à La Guillaume et al. [24] illuminated n-region of the p-n junction in Ge at $T = 2^\circ\text{K}$ and measured the electric current in the circuit. Excited excitonic complexes diffused towards the junction and short random pulses of photovoltaic current were observed, resulting from the dissociation of complexes in the field of the p-n junction. If the excitonic complexes had been biexcitons, each pulse should have corresponded to the contribution of two electrons; it was found, however, that pulses consisted of $\approx 10^7$ elementary charges*). From here we can specify the radius of electron-hole drop: $r \approx 3 \mu$.

As we have mentioned, the volume occupied by drops has metallic character, in contrast to its surroundings (after reaching the critical concentration of excitons an abrupt increase of conductivity has been observed in Ge [27]). It means the refractive index in the drops should differ from that of the crystal lattice. The crystal becomes optically inhomogeneous and a scattering of a probe light beam in the crystal should become observable, in analogy with the scattering of light by drops in a fog. From such a consideration Pokrovskij and Svistunova started and the expected scattering have really discovered in Ge [26]. Their experimental set-up is shown in Fig. 9. A sample 1 was excited by radiation 2 from a tungsten lamp and a changeable screen ring window 5 was used to separate the light scattered at angles $\Theta \pm \Delta \Theta$ ($\Delta \Theta \approx 1^\circ$) from the probe laser beam 3 ($\lambda = 3,39 \mu$). A set of eight windows

*) Similar values is reported by asnin et al. [25].

corresponding to different angles made it possible to determine the angular distribution $U_{sc}(\theta)$ of the scattered light. The scattered light was focused by a quartz condenser 6 onto a photoresistor 7. Fig. 10 shows the dependence of $U_{sc}(\theta)$ on a dimensionless parameter $(2\pi/\lambda)r\theta$. The solid line is calculated according to the

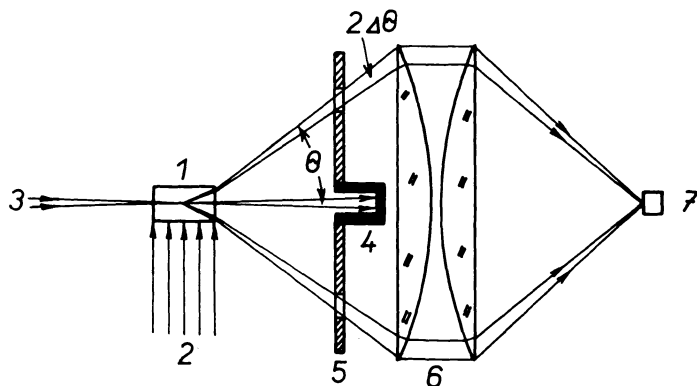

Fig. 9. Experimental set-up for the investigation of light scattering by electron-hole drops [26]. $T = 2,1^{\circ}K$

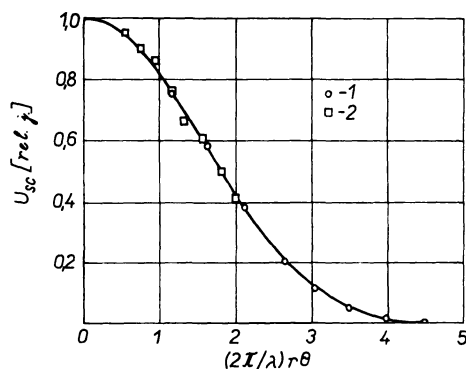

Fig. 10. Angular distribution of the scattered light intensity $U_{sc}(\theta)$. 1 — a laser beam distance from the illuminated sample surface $l = 0,5$ mm, 2 — $l = 1$ mm

Rayleigh theory for scattering by spherical particles. The drop radius r was found from the best fit of experimental points to the theoretical curve. For a laser beam distance from the illuminated surface 0.5 mm the best fit was reached with $r = 7.6 \mu$, for distance of 1 mm with $r = 3.4 \mu$. Both the method of the photovoltaic detection of electron-hole drops and the observation of light scattering thus give very similar values of r .

To this limited review only several typical experimental results have been involved. For completion, let us at least mention a study of the electron-hole drops

far-infrared absorption [28], [29], of the impurity influence on the electron-hole drops formation [30] and the observation of cyclotron resonance in drops [31]. A reader may find additional references in the review articles [19] and [32].

4. Conclusion

Haynes [15] in 1966 first observed the new low-temperature emission line in Si and attributed this line to the recombination radiation of biexciton. Only a number of subsequent theoretical and experimental works shows this interpretation to be most probably incorrect, and that in Ge and Si under high concentration of excitons the condensed phase appears. On the other hand, in crystal of CuCl-type the situation is favourable for the formation of excitonic molecule and a position of a new emission line in the luminescence spectrum of CuCl [33]–[35] is in good agreement with the binding energy of biexciton calculated after theoretical works [36]–[38]. An extensive analysis of this problem together with discussion of another properties of highly excited crystals can be found in the review [39].

Up-to-date results of the exciton condensation in semiconductors are very interesting even from the point of view of miscellaneous approaches to the problem. There remains much vague yet — e.g. a question of the liquid and gas phase co-existence (surface energy of the drops), the nature of condensation centers etc. Further investigations of properties of the condensed phase in various semiconductors will undoubtedly bring help to understanding of all these questions, and thus to the further development of the physics of semiconductors in general.

Acknowledgements

Discussions with prof. K. Vacek are greatly appreciated.

References

- [1] LAMPERT M. A., *Phys. Rev. Letters* **1** (1958), 450.
- [2] KELDYŠ L. V., in *Trudy IX. mezhdun. konf. po fizike poluprov.*, Moskva 1968, Nauka Leningrad 1969, 1384.
- [3] ASNIN V. M., ROGAČEV A. A., SABLINA N. A., *Fiz. i tech. poluprov.* **4** (1970), 808.
- [4] HANAMURA E., INOUE M., in *Proc. 11. Int. Conf. on the Phys. of Semicond.*, Varšava 1972, Polish Sci. Publish. Varšava 1972, 711.
- [5] ASNIN V. M. et al., in [4], 718.
- [6] BENOIT A LA GUILLAUME C., VOOS M., SALVAN F., *Phys. Rev. B* **5** (1972), 3079.
- [7] BRINKMAN W. F. et al., *Phys. Rev. Letters* **28** (1972), 961.
- [8] HUBBARD J., *Proc. Roy. Soc. A* **243** (1957), 336.
- [9] COMBESCOT M., NOZIÈRES P., *J. Phys. C.: Solid State Physics* **5** (1972), 2369.
- [10] NOZIÈRES P., PINES D., *Phys. Rev.* **111** (1958), 442.
- [11] POKROVSKIJ JA. E., SVISTUNOVA K. I., *Fiz. i tech. poluprovod.* **4** (1970), 491.
- [12] KAMINSKIJ A. S., POKROVSKIJ JA. E., ALKEEV N. V., *Ž. exp. teoret. fiz.* **59** (1970), 1937.
- [13] POKROVSKIJ JA. E., SVISTUNOVA K. I., *Pisma Ž. exp. teoret. fiz.* **9** (1969), 261.
- [14] BENOIT A LA GUILLAUME C., SALVAN F., VOOS M., *J. Lumin.* **1/2** (1970), 315.

- [15] HAYNES J. R., Phys. Rev. Letters **17** (1966), 860.
- [16] BENOÎT À LA GUILLAUME C., VOOS M., SALVAN F., Phys. Rev. Letters **27** (1971), 1214.
- [17] BILLE J. et al., in [4], 183.
- [18] CUTHBERT J. D., Phys. Rev. B **1** (1970), 1552.
- [19] POKROVSKIJ JA. E., in [4], 69.
- [20] POKROVSKIJ JA. E., SVISTUNOVA K. I., ALKEEV N. V., Fiz. tv. tela **14** (1972), 3306.
- [21] BAGAEV V. S. et al., Pisma Ž. exp. teoret. fiz. **10** (1969), 309.
- [22] ALEKSEJEV A. S., BAGAEV V. S., GALKINA T. I., Ž. exp. teoret. fiz. **63** (1972), 1020.
- [23] BETZLER K., CONRADT R., in [4], 684.
- [24] BENOÎT À LA GUILLAUME et al., Compt. Rend. B **272** (1971), 236.
- [25] ASNIN V. M., ROGAČEV A. A., SABLINA N. I., Pisma Ž. exp. teoret. fiz. **11** (1970), 162.
- [26] POKROVSKIJ JA. E., SVISTUNOVA K. I., Pisma Ž. exp. teoret. fiz. **13** (1971), 297.
- [27] ASNIN V. M., ROGAČEV A. A., Pisma Ž. exp. teoret. fiz. **7** (1968), 464.
- [28] VAVILOV V. S., ZAJAC V. A., MURZIN V. N., Pisma Ž. exp. teoret. fiz. **10** (1969), 314.
- [29] MURZIN V. N., ZAJAC V. A., KONOLENKO V. L., in [4], 678.
- [30] ALEKSEJEV A. S. et al., Fiz. tv. tela **12** (1970), 3516.
- [31] HENSEL J. C., PHILLIPS T. G., in [4], 671.
- [32] BENOÎT À LA GUILLAUME C., in [4], 659.
- [33] BIVAS A. et al., J. Physique **31** (1970), 227.
- [34] SOUMA H., GOTO T., OHTA T., J. Phys. Soc. Japan **29** (1970), 697.
- [35] SHAKLEE K. L., LEHENY R. F., NAHORY R. E., Phys. Rev. Letters **26** (1971), 888.
- [36] SHARMA R. R., Phys. Rev. **170** (1968), 770.
- [37] WEHNER R. K., Solid State Com. **7** (1969), 457.
- [38] BOBRYŠEVA A. I., MIGLEI M. F., ŠMIGLJUK M. I., Phys. Stat. Sol. b **53** (1972), 71.
- [39] LEVY R., GRUN J. B., This seminar.